

### 1. COLOCACIÓN DE ADHESIVO A LA PILETA / PLACING THE ADHESIVE TO THE SINK

Colocar la piletta en el traforo del plano de la mesada, previa aplicación de un cordón de silicona con fungicida en todo el perímetro de la piletta.

Put the sink in the orifice of the countertop's plane, previous to the application of silicone based sealants with fungicide on the entire perimeter of the sink.

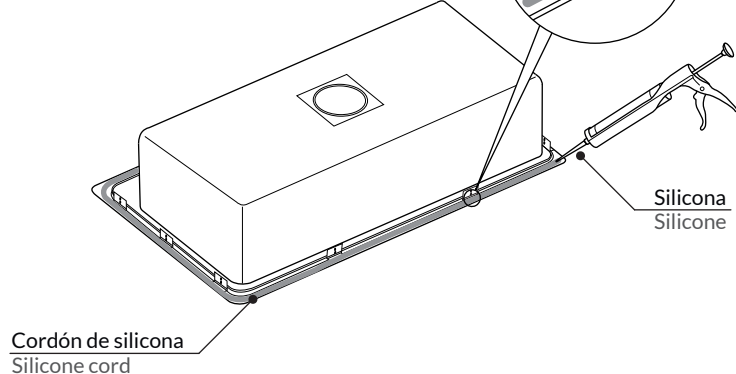

### 3. AJUSTES DE GRAMPAS / CLAMP ADJUSTMENTS

Proceder al ajuste del tornillo de la grampa con destornillador manual, asegurando que las garras de la grampa queden apoyando sobre la parte inferior de la mesada (ver esquema de fijación paso nº2). El ajuste de las grampas debe realizarse de manera pareja y secuencial por cada lado de la piletta a la vez, ayudando con la presión de la mano sobre el borde de la piletta, de manera tal que la misma apoye sobre el plano de la mesada (ver esquema de secuencia de ajuste). El ajuste de los tornillos se debe realizar hasta que la piletta quede en contacto con la mesada. Efectuarlo en demasía puede provocar deformaciones permanentes y daños en el producto.

Nota: la presencia de ondulaciones en el borde perimetral de la piletta antes de su instalación no implica inconvenientes para el correcto montaje del producto.

Proceed with the tightening of the screw of the staple using a manual screwdriver. Be sure to have the claws of the staple leaning against the bottom of the countertop. (See fixing diagram step nº2). The tightening of the staples must be carried out evenly and sequentially by each side of the sink at the same time; helping yourself with the pressure of your hand over the edge of the sink, so that it leans against the plane of the countertop. (See the adjustment sequence diagram). The tightening of the screws must be done until the sink is in contact with the countertop. Tightening the screws in excess can cause damage and permanent deformation to the product. Note: the presence of ripples in the perimeter edge of the sink before its installation does not cause inconveniences to properly assemble the product.

### 2. COLOCACIÓN DE LA PILETA A LA MESADA / PLACING THE SINK TO THE TABLE

Colocar las grampas en las escuadras de la piletta introduciendo el gancho en el ojal correspondiente al espesor de la mesada.

Insert the staples into the square of the sink by introducing the peg into the buttonhole that corresponds to the countertop thickness.

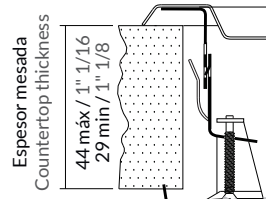
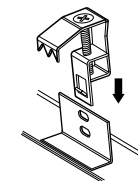

**Espesor de mesada entre 44 y 29 mm**  
Insertar la grampa de fijación en la primera perforación de la escuadra.

**Thickness of the countertop between 1" 1/16 to 1" 1/8**  
Placing the fixation clamps in the first perforation of the squad.

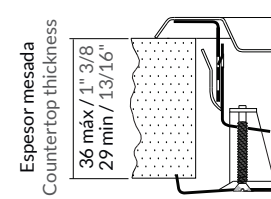

**Espesor de mesada entre 36 y 21 mm**  
Insertar la grampa de fijación en la primera perforación de la escuadra.

**Thickness of the countertop between 1" 3/8 to 13/16"**  
Placing the fixation clamps in the first perforation of the squad.

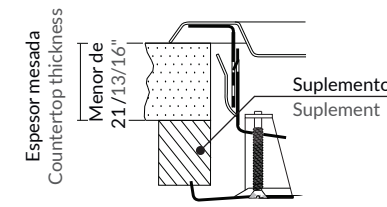

**Espesor de mesada menor de 21 mm**  
Se deberá colocar un suplemento (no provisto).

**Thickness of the countertop is smaller than 13/16"**  
Supplement it will be placed (not provided).

### 4. COLOCACIÓN DE ARANDELAS / PLACEMENT OF WASHERS

Colocar las arandelas suplementos debajo de las perforaciones para grifería o dosificador según corresponda.

Place the washers supplements under the holes for faucets or metering system accordingly.

Arandela suplemento de dosificador diámetro 25 mm.  
Washer supplement dispenser diameter 1"

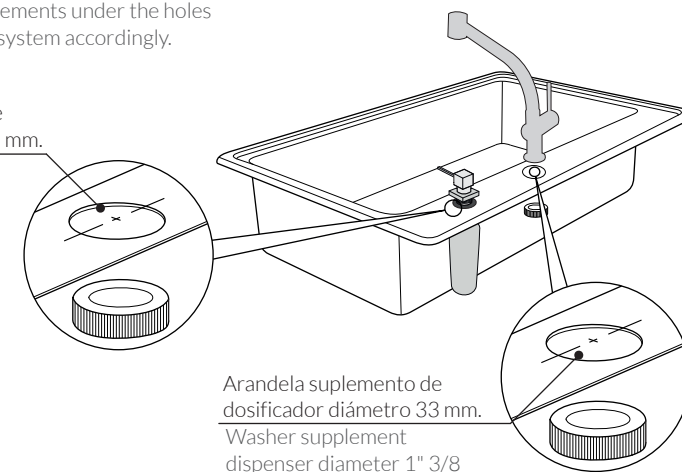

#### Secuencia de ajuste / Tightening sequence

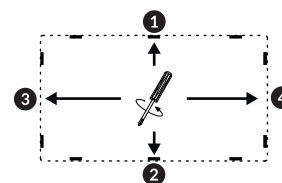

**Nota:** No utilizar atornilladores eléctricos o neumáticos en el montaje. Utilizar solamente atornillador manual.

**Note:** Do not use electric or pneumatic screwdrivers when mounting. Use only hand screwdriver.

MEDIDAS DE TRAFORO PARA MESA / ORIFICE MEASURES FOR COUNTERTOP

QUADRA MAX Q71 A

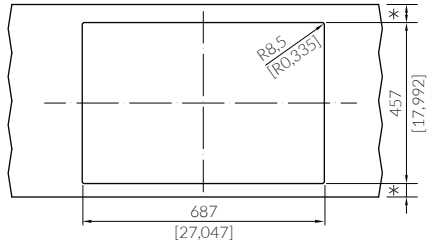

QUADRA Q76 A

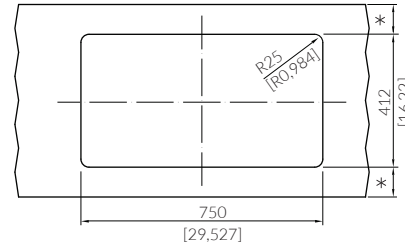

QUADRA Q85 A

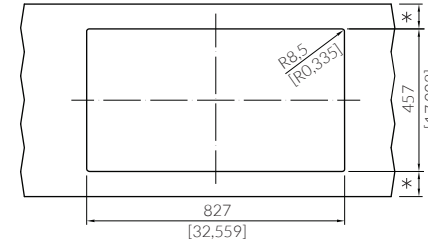

QUADRA Q84 A

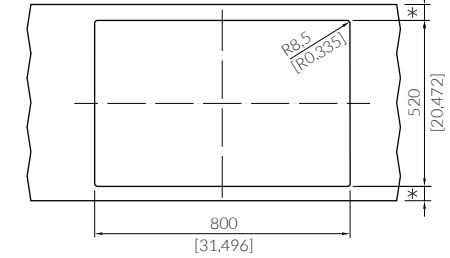

QUADRA MINI Q55 A

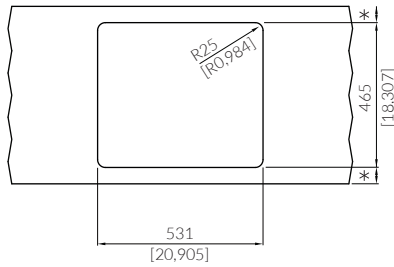

LUXOR SI85 A - LUXOR SI85 STA

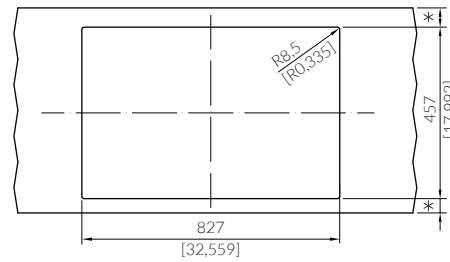

LUXOR MINI SI55 A

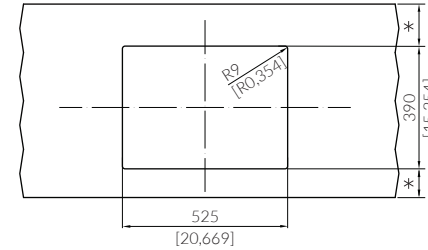

LUXOR COMPACT SI71 A - LUXOR COMPACT SI71 STA

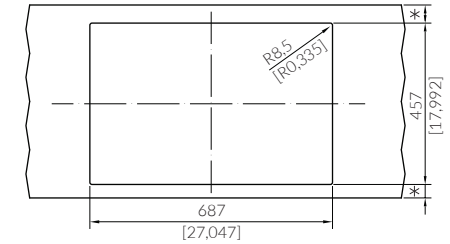

AXA D78 A

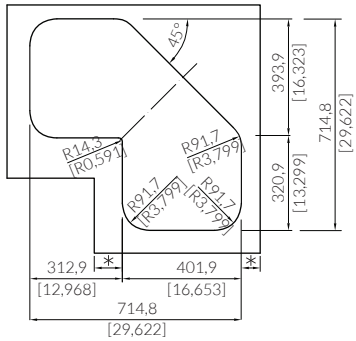

HYDRA J107 A

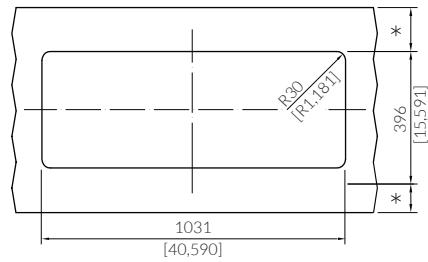

E 60 A

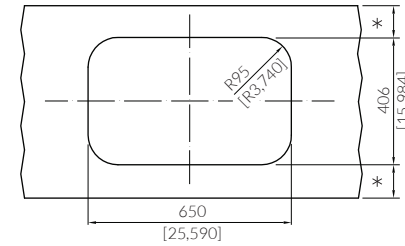

CURVE SI77 A

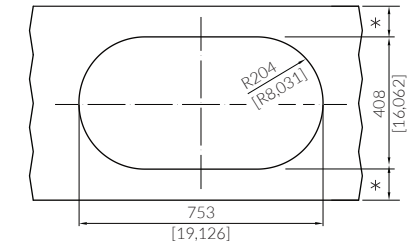

ZARA D84 A

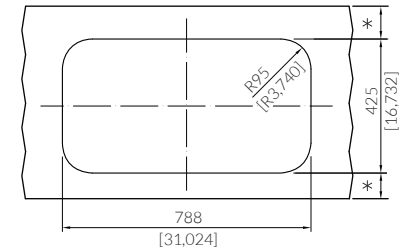

ZN 52/18 A - ZN 52/18 A CR

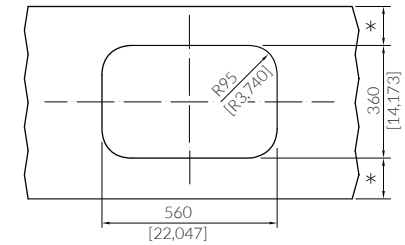

\* Dimensiones a cargo del fabricante de mesada

\* Dimension in charge of the countertop maker

Por avances tecnológicos Johnson Acero S.A se reserva el derecho de actualizar las especificaciones sin previo aviso. Tampoco se responsabiliza por la realización de traforos para piletas y su instalación incorrecta.

By technological advances Johnson Acero S.A. it reserves the right to update technical specifications without notice. No responsibility for the realization of orifice for pools and improper installation.

Consulte por actualizaciones y nuevos servicios: Check for updates and new services: info@johnsonacero.com Tel.:+543434261000